

Lucent Technologies
Bell Labs Innovations



A Portable Guide to Voice Messaging

585-300-701
Comcode 107395352
Issue 3
November 1994

Notice

Every effort was made to ensure that the information in this book was complete and accurate at the time of printing. However, information is subject to change.

Your Responsibility for Your System's Security

Toll fraud is the unauthorized use of your telecommunications system by an unauthorized party, for example, persons other than your company's employees, agents, subcontractors, or persons working on your company's behalf. Note that there may be a risk of toll fraud associated with your telecommunications system and, if toll fraud occurs, it can result in substantial additional charges for your telecommunications services.

You and your system manager are responsible for the security of your system, such as programming and configuring your equipment to prevent unauthorized use. The system manager is also responsible for reading all installation, instruction, and system administration documents provided with this product in order to fully understand the features that can introduce risk of toll fraud and the steps that can be taken to reduce that risk. Lucent Technologies does not warrant that this product is immune from or will prevent unauthorized use of common-carrier telecommunication services or facilities accessed through or connected to it. Lucent Technologies will not be responsible for any charges that result from such unauthorized use.

Lucent Technologies Fraud Intervention

If you *suspect that you are being victimized* by toll fraud and you need technical support or assistance, call Technical Service Center Toll Fraud Intervention Hotline at 1 800 643-2353.

Federal Communications Commission Statement

Part 15: Class B Statement. This equipment has been tested and found to comply with the limits for a Class B digital device, pursuant to Part 15 of the FCC Rules. These limits are designed to provide reasonable protection against harmful interference in a residential installation. This equipment generates, uses, and can radiate radio-frequency energy and, if not installed and used in accordance with the instructions, may cause harmful interference to radio communications. However, there is no guarantee that interference will not occur in a particular installation. If this equipment does cause harmful interference to radio or television reception, which can be determined by turning the equipment off and on, the user is encouraged to try to correct the interference by one or more of the following measures:

- Reorient the receiving television or radio antenna where this may be done safely.
- To the extent possible, relocate the receiver with respect to the telephone equipment.
- Where the telephone equipment requires ac power, plug the telephone into a different ac outlet so that the telephone equipment and receiver are on different branch circuits.

Part 68: Network Registration Number. This equipment is registered with the FCC in accordance with Part 68 of the FCC Rules. It is identified by FCC registration number AS593M-11185-MF-E.

Part 68: Answer-Supervision Signaling. Allowing this equipment to be operated in a manner that does not provide proper answer-supervision signaling is in violation of Part 68 rules. This equipment returns answer-supervision signals to the public switched network when:

- Answered by the called station
- Answered by the attendant
- Routed to a recorded announcement that can be administered by the CPE user

This equipment returns answer-supervision signals on all DID calls forwarded back to the public switched telephone network. Permissible exceptions are:

- A call is unanswered
- A busy tone is received
- A reorder tone is received

Trademarks

DEFINITY is a registered trademark of Lucent Technologies in the U.S. and throughout the world.

AUDIX is a registered trademark of Lucent Technologies.

Ordering Information

Call: Lucent Technologies Publications Center
Voice 1 800 457-1235 International Voice 317 361-5353
Fax 1 800 457-1764 International Fax 317 361-5355

Write: Lucent Technologies Publications Center
P.O. Box 4100
Crawfordsville, IN 47933

Order: Document No. 585-300-701
Comcode 107395352
Issue 3, November 1994

For additional documents, refer to the section entitled, "Related Documents" in "About This Book."

You can be placed on a Standing Order list for this and other documents you may need. Standing Order will enable you to automatically receive updated versions of individual documents or document sets, billed to account information that you provide. For more information on Standing Orders, or to be put on a list to receive future issues of this document, please contact the Lucent Technologies Publications Center.

Warranty

Lucent Technologies provides a limited warranty on this product. Refer to the "Limited use Software License Agreement" card provided with your package.

European Union Declaration of Conformity

Lucent Technologies Business Communications Systems declares that XXX equipment specified in this document conforms to the referenced European Union (EU) Directives and Harmonized Standards listed below:

EMC Directive 89/336/EEC

Low Voltage Directive 73/23/EEC



The "CE" mark affixed to the equipment means that it conforms to the above Directives.

Disclaimer

Intellectual property related to this product and registered to AT&T Corporation has been transferred to Lucent Technologies Incorporated.

Any references within this text to American Telephone and Telegraph Corporation or AT&T should be interpreted as references to Lucent Technologies Incorporated. The exception is cross references to books published prior to December 31, 1996, which retain their original AT&T titles.

Heritage

Lucent Technologies - formed as a result of AT&T's planned restructuring - designs, builds, and delivers a wide range of public and private networks, communication systems and software, consumer and business telephone systems, and microelectronics components. The world-renowned Bell Laboratories is the research and development arm for the company.

Acknowledgment

This document was prepared by the Product Documentation Development group, Lucent Technologies, Denver, CO and Columbus, OH.

<u>Welcome</u>	<u>1</u>
■ <u>Call Answering</u>	<u>1</u>
■ <u>Voice Mail</u>	<u>1</u>
■ <u>Voice Prompts and Help</u>	<u>1</u>
<u>Terms/Concepts</u>	<u>2</u>
■ <u>Incoming Messages (Received by you)</u>	<u>4</u>
■ <u>Outgoing Messages (Sent by you)</u>	<u>4</u>
<u>Tips and Highlights</u>	<u>5</u>
■ <u>General</u>	<u>5</u>
■ <u>Getting Messages</u>	<u>6</u>
■ <u>Leaving Messages When No One Answers</u>	<u>8</u>
■ <u>Recording Voice Mail</u>	<u>9</u>
■ <u>Sending Voice Mail</u>	<u>9</u>
<u>Logging In</u>	<u>11</u>
<u>Record Your Name</u>	<u>12</u>
■ <u>Tips</u>	<u>12</u>
<u>Change Your Password</u>	<u>13</u>
<u>Record and Send Messages</u>	<u>14</u>
■ <u>Recording Your Message</u>	<u>14</u>
■ <u>Editing Your Message</u>	<u>14</u>
■ <u>Addressing Your Message</u>	<u>14</u>
■ <u>Tips</u>	<u>14</u>
■ <u>Delivering Your Message</u>	<u>15</u>
■ <u>Tips</u>	<u>15</u>

<u>Get and Respond to Messages</u>	<u>16</u>
■ <u>Listen to Header or Message</u>	<u>16</u>
■ <u>Respond to Header or Message</u>	<u>16</u>
■ <u>Act on Header/Message</u>	<u>16</u>
<u>Scan Messages Quickly</u>	<u>17</u>
<u>Create Personal Greetings-Basic</u>	<u>18</u>
■ <u>Record Greeting</u>	<u>18</u>
■ <u>Edit</u>	<u>18</u>
■ <u>Act on New Greeting</u>	<u>18</u>
■ <u>Tips</u>	<u>18</u>
■ <u>Activate Previously Recorded Greetings</u>	<u>18</u>
■ <u>Scan All Greetings</u>	<u>19</u>
<u>Create Personal Greetings-Advanced</u>	<u>20</u>
■ <u>Define Call Types (the first time)</u>	<u>20</u>
■ <u>Tips</u>	<u>20</u>
■ <u>Call Types</u>	<u>21</u>
■ <u>Change Call Type Definition</u>	<u>21</u>
■ <u>Tips</u>	<u>21</u>
■ <u>Assign Greetings to Call Types</u>	<u>22</u>
■ <u>Tips</u>	<u>22</u>
<u>Multiple Personal Greetings Flowchart</u>	<u>23</u>
<u>Outgoing/Filed Messages</u>	<u>24</u>
■ <u>Access Outgoing Messages</u>	<u>24</u>
■ <u>Select Message</u>	<u>24</u>
■ <u>Modify Message</u>	<u>24</u>
■ <u>Resend Message</u>	<u>25</u>

<u>Mailing Lists</u>	<u>26</u>
■ <u>Create List</u>	<u>26</u>
■ <u>Delete List</u>	<u>26</u>
■ <u>Scan List Summaries</u>	<u>26</u>
■ <u>Tips</u>	<u>26</u>
■ <u>Review/Modify List</u>	<u>27</u>
<u>Personal Directory</u>	<u>28</u>
■ <u>Create/Append Directory</u>	<u>28</u>
■ <u>Tips</u>	<u>28</u>
■ <u>Application</u>	<u>28</u>
■ <u>Review/Delete Directory</u>	<u>29</u>
<u>Use Directory Assistance</u>	<u>30</u>
■ <u>Tips</u>	<u>30</u>
<u>Leave a Call Answer Message</u>	<u>31</u>
<u>Mailing Lists Log</u>	<u>32</u>
■ <u>List ID</u>	
<u>Group Name</u>	<u>32</u>
<u>Personal Greetings Log</u>	<u>33</u>
<u>Command Summary</u>	<u>34</u>
■ <u>Notes</u>	<u>36</u>

Welcome

Your AUDIX[®] voice messaging system is a complete call answering and voice mail system.

Call Answering

AUDIX answers your calls when you are unavailable or too busy to answer your phone. Callers can then leave messages in your voice “mailbox.” Later, at a time convenient to you, you can access your mailbox to get those messages.

AUDIX also lets you leave messages in the voice mailboxes of other AUDIX users when they don’t answer their phones.

Voice Mail

AUDIX also lets you record messages in advance and send them directly to the voice mailboxes of other AUDIX users — without actually calling their phones.

Conversely, other users can record and send voice mail messages directly to *your* mailbox. When convenient, you can access your mailbox to get those messages.

Voice Prompts and Help

AUDIX voice prompts tell you what to do at every step in a task. Once you have selected the appropriate Activity Menu option (see page 2), you can rely solely on the voice prompts to figure out what to do. *You really don’t need this book.*

Press * **H** (Help) or * **4** to find out what step you’re on in a task and what your options are. Always use * **H** when you forget what to do next.

NOTE: The * * **U** (or * * **8**) command to recover the message you just deleted (see pp. 16 & 34) and the **#** command to back out of the Reply to Sender option are not available on Intuity AUDIX R2.0 voice messaging systems, but they *are* available on Intuity AUDIX R3.2 systems.

Terms/Concepts

Activity Menu The initial activities you can select after logging into the system.

ACTIVITY MENU

Record and Send 1	Get and Respond ABC 2	Create Personal Greetings DEF 3
Outgoing/ Filed Messages GHI 4	Password/ Mailing List/ Personal Dir. JKL 5	
Scan PRS 7	<p>After you log in, you use your phone keys to access menu options. There are layers of menus, and their options are described as you progress through each activity. The first layer is called the Activity Menu. You can always get back to that layer by pressing *R (or *7) to Return to Main Menu.</p>	

* R 7 = Return to Activity Menu	* H 4 = Help
--	-----------------------------

Header

A summary of an incoming message (equivalent to a return address and post-mark on a letter). It includes the length of the message in minutes and/or seconds: *"Message from John Parrot received 7:34 AM, Friday, April first, 70 seconds, extension 23741."*

Address

A number or a name specified for an outgoing message (equivalent to an address on a letter).

Terms/Concepts (Cont)

AUDIX Mailbox Your personal storage area for incoming and outgoing messages (and headers).

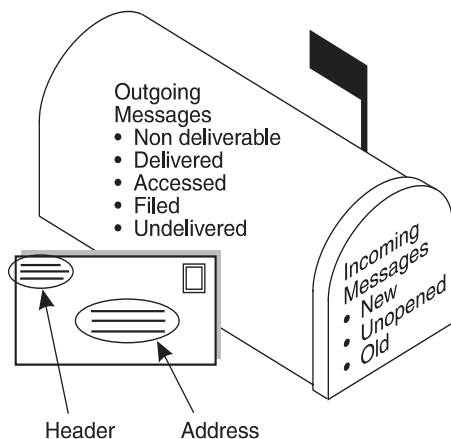

Your incoming and outgoing messages are stored in categories according to their status. The system keeps incoming messages until you delete them or until an automatic deletion date. Because space is limited, it is wise to regularly review and delete messages.

Terms /Concepts (Cont)

Incoming Messages (Received by you)

New	Messages you have not yet retrieved.
Unopened	Messages of which you have listened to the headers, but not the message itself.
Old	Messages you have listened to but have not yet deleted.

Outgoing Messages (Sent by you)

Delivered	Messages that have been delivered but have not yet been listened to by the recipient.
Accessed	Messages that have been delivered and listened to by the recipient.
Undelivered	Messages that have not yet been sent because you scheduled them for future delivery. You can listen to, re-address, and re-record these messages any time before delivery.
Nondeliverable	Messages that could not be delivered, usually because the intended recipient's mailbox is full. You can listen to, re-address, and re-record these messages.
Filed	Copies of outgoing messages that you saved to resend and/or modify.

Tips and Highlights

General

- | | |
|--------------------------------|--|
| Log in quickly | From <i>your</i> phone, dial the system number, press # only (you don't need to type your extension), and enter your password. |
| Log in from anywhere | <p>From a phone connected to your company's system, dial the system extension, then enter your extension and password.</p> <p>From any phone <i>not</i> connected to your company's system, dial the complete phone number, including local prefix (and the area code if long distance), then enter your extension and password.</p> |
| Log in after leaving a message | After you get the greeting for another user's voice mailbox, you can press * R to log into your voice mailbox. Press * R immediately or leave a message and then press * R . This tip is extra useful for long distance or pay calls because you can leave and get messages with one phone call. |
| Dial ahead | If you know what buttons to push, push them without waiting for the system to respond. NOTE: You can't bypass error beeps and important system messages. |

Tips and Highlights (Cont)

- Use Help** For help, press * **H** or * **4**. The system states your current options or the next step.
- Avoid using obvious passwords** **Do not** use a password that would be easy for someone else to guess. See page 13.
- Also, **do not** put your password on a programmable function key or speed-dial key.

Getting Messages

- Scan messages quickly** You can automatically play all of your messages by pressing just two buttons. Scanning is extra useful with a car phone. See page 17.
- Use playback controls** When listening to messages, you have controls for loudness, speed, stepping back and forth pausing, and repeating messages. See page 34.
- Make your mailbox bigger when away** When you're on vacation or away from your phone for an extended period, ask your system administrator to temporarily make your mailbox bigger. You'll reduce the chance of it filling up so callers can't leave messages. Also, change your personal greeting to tell callers who else to talk to while you're away.

Tips and Highlights (Cont)

Record a personal greeting

Replace the automatic system greeting with your personal hello. See page 18. Tell callers they can press **1** to skip your greeting and press * **H** or * **4** for help.

Change your greeting everyday to match your daily schedule and record multiple greetings that play according to call type. See page 20.

Delete old messages

Your mailbox has limited space. When it's getting full, the system tells you. Delete messages or greetings you don't need.

Answer messages from your mailbox

Answer a message sent by another user immediately after listening to it, either by pressing **1 0** to call the person or by pressing **1 7**, **1 1 9**, or **1 1 6** to send them a return voice mail message. See page 16.

Forward messages

You can forward a message to another user or a list of users immediately after listening to it. After you forward it, you return to the original place in your mailbox. See page 16. To forward to a mailing list, press * **L** or * **5** to specify the list's address.

Tips and Highlights (Cont)

Leaving Messages When No One Answers

- | | |
|---|--|
| Use play-back and record controls | To listen to and edit the messages you leave when there's no answer, you have many controls. See pages 31 and 34. |
| Bypass greetings and record immediately | You don't have to listen to another user's call answer greeting. You can, instead, press 1 to bypass the greeting and begin recording immediately. |
| Use directory assistance | If you don't know the extension of another user, find it with your voice messaging system. Log in, press **N or **6 and enter the person's name, last name first. The system tells you the extension. |
| Transfer to an extension | Before or after leaving a message for another user, you can transfer to another extension. To do this, press *T or *8 . Then enter the extension and # . NOTE: this option may not be active on your system. |
| Transfer to operator | Before or after leaving a message for another user, you can transfer to the user's secretary or operator by pressing 0 . NOTE: this option may not be active on your system. |
| Make messages priority | When you want someone to listen to your message right away, send it as a priority message. See page 31. NOTE: this option may not be available for all users. |

Tips and Highlights (Cont)

Make messages private To prevent another user from forwarding a message you leave, make it private. See page 31.

Use a guest password To save time, leave messages directly in another user's mailbox. Dial the system number, then enter the extension and guest password (available from your system administrator). You can leave messages, but you can't get messages.

Customers or other callers can also save time by using the guest password. So give it to them, along with your system number and extension.

Recording Voice Mail

Use playback and record controls To listen to and edit the messages you send, you have many controls. See pages 14 and 34.

Sending Voice Mail

Make messages priority When you want someone to listen to your message right away, send it as a priority message. See page 15.
NOTE: this option may not be available for all users.

Make messages private To prevent another user from forwarding a message you send, make it private. See page 15.

Tips and Highlights (Cont)

- | | |
|---|--|
| Save messages you send | Before sending a message, you can save it in the Outgoing Message file by pressing 4 . Retrieve the message later to use again. See pages 15 and 24. |
| Check on receipt of messages you send | After you send a message, check your Outgoing Message file to see if the message was delivered and if the person listened to it. See page 24. |
| Delete outgoing/ filed messages | Delete messages filed in the Outgoing Message file. Filed outgoing messages can unnecessarily use system storage. |
| Schedule delivery | Schedule a message for delivery to others at a specified time and date. Use the system as a calendar/reminder by scheduling messages to yourself. See page 15. |
| Use mailing lists | Create a mailing list of extensions. Then send your message to one destination — the mailing list. All extensions in the list receive the message. See page 26. You can also forward messages to a mailing list. |
| Send messages to a name, not an extension | When you send a message and don't know the extension of the recipient, press * A or * 2 . Then enter the person's name, last name first. * A or * 2 switches you back and forth between extension and name . |

Logging In

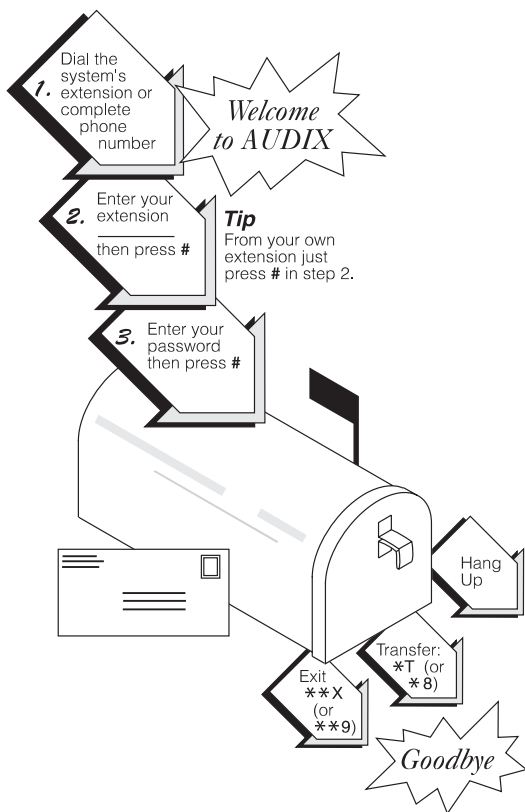

After you log in, you are at the Activity Menu (see page 2). The system voice prompts tell you what to do and what your options are. At any time, press * H or * 4 to get information about your current options.

Important: Change your password immediately after you log into AUDIX the first time. The system may require you to do this. See page 13.

Record Your Name

Record your own name to replace the system greeting for your voice mailbox. Callers will hear your voice instead of AUDIX and feel more comfortable about leaving messages.

If the system asks you to record your name as you log in, **you must press 1 and begin at step 2** in the instructions below. You can record your name at any time after logging in by following the entire procedure, beginning at step 1.

1. Press **5 5** from the Activity Menu.
2. Say your name after the tone.
3. Press **1**.

OPTIONAL

4. Press one of the following
 - **1** to re-record (return to step 2).
 - **2 3** to play back.

5. Press **1**.
6. Press **#** to approve.

Tips

You usually don't have to wait for the voice prompts. In most cases, you can dial through them to enter a command *without waiting* and *from anywhere in the system*. You can't dial through errors and important messages the system wants you to hear. When you try to dial through prompts at these times, you hear a beep.

After leaving a call answer message, access your own voice mailbox by pressing *** R** or *** 7**. **NOTE:** this capability may not be available on your system.

Schedule a voice message to yourself as a meeting reminder (p. 15).

Change Your Password

Change your password **immediately** after you become an AUDIX subscriber. You should also continue to change your password at least once every three months.

If the system asks you to change your password as you log in, **you must press 1 and begin at step 2** in the instructions below. You can change your password at any time after logging in by following the entire procedure, beginning at step 1.

1. Press **5 4** from the Activity Menu.
2. Enter new password (up to 15 digits) and press #.
3. Re-enter new password and press #.

Caution:

Do not use a password that uses:

- Ascending or descending digits (for example, 1234 or 4321)
- The same digits (for example 0000)
- Digits corresponding to your name or initials (for example, 5646 for John)
- Current year (for example, 1993)
- The same number as your extension (for example, extension 3455, password 3455)
- Reverse extension (for example, extension 3455, password 5543)
- Numbers that identify you, such as your social security number, employee ID, room number, or department

Also, **do not** put your password on a programmable function key or speed-dial key.

Record and Send Messages

Recording Your Message

1. Press **1** from the Activity Menu.
You can skip the prompt by pressing **1** again.
2. Record at the tone.

• Press **1** to stop recording or pause.

Editing Your Message

- OPTIONAL
- Press one of the following:
 - **1** to continue recording.
 - **2 3** to play back. See additional Playback Options on page 17 or 34.
 - *** D** or *** 3** to delete (and begin again)

3. Press **#** to approve message.

Addressing Your Message

4. Do one of the following:
 - Enter recipient's address and press **#**.
 - To send to multiple recipients via a mailing list:
 - a. Press *** L** to access a list.
 - a. Enter list owner's extension and press **#**. (If you're the owner, just press **#**.)
 - a. Enter list ID (name) and press **#**.Repeat step 4 for additional recipients.
5. Press **#** to approve addressing.

Tips

Press *** A** or *** 2** to switch between number and name addressing. Enter last name first. (See the alpha-betic keypad reference on page 34.)

You can use only your mailing lists and those of other users on your Audix system.

Press *** D** or *** 3** to delete an incorrect address or list.

To review addresses press *** 1**.

Record and Send Messages

Delivering Your Message

6. Press # to deliver immediately.

Or, do any combination of the following:

Delivery Options

- Press **0** to have the system recite this list of options to you.
- Press **1** to make your message private. (Press **1** again to undo.)
- Press **2** to make your message priority (if available). (Press **2** again to undo.)
- Press **3** to schedule delivery. (Press **3** again to undo.)
- Press **4** to file a copy. (Press **4** again to undo.)

Then press # to approve and deliver.

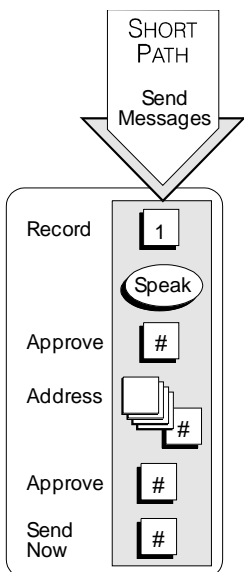

To schedule delivery:

- a. Enter delivery time (**405** = 4:05).
- a. Enter **A** (or **2**) for AM or **P** (or **7**) for PM and press #.
- a. Enter delivery month and day (**502** = May 2) and press #.
- a. Press # to approve or * **3** (or * **D**) to start over.

Tips

Filed messages can be modified and sent again. See page 24.

Get and Respond to Messages

1. Press **2** from the Activity Menu.

Listen to Header or Message

2. Press any combination of the following:
 - **0** to listen to the message.
 - **2** to rewind the message (or return to previous).
 - **2 3** to play back the header.
 - (See other playback options on the next page.)

Respond to Header or Message

You can respond to a message during or after listening to the message or header.

OPTIONAL

3. Do one of the following :
 - To reply to sender by voice mail, press **1 1 6** or **1 1 7**. To reply and attach original, press **1 1 9**. After recording, press **#** to approve, then schedule delivery or press **#** to send now.
 - To call sender, press **1 0**.
 - To record a message to someone other than the sender, press **1 4**. (See "Record and Send Messages" steps 2 - 6 to complete this or the next option. Use *** L** or *** 5** to send to mailing lists.)
 - To forward with comment, press **1 2**.
 - To escape back to step 2, press **#** (may not be available with your system)

Act on Header/Message

4. Press any combination:
 - *** D** or *** 3** to delete message.
 - *** * U** or *** * 8** to restore the last message you deleted (not available with all systems).
 - **#** to save and skip to the next message.
 - *** * H** or *** * 4** to hold message in current category and skip to next message.
 - * #** to skip to the next message category

Tips

Pressing *** * H** or *** * 4** to hold a message in the New category lets your message waiting indicator stay on.

When recording a response, press **1** to skip the record prompt.

The system saves messages for the length of time set by your administrator. delete them.

Each message header tells you the length of the message in minutes and/or seconds.

Scan Messages Quickly

Once you are familiar with how to get messages, try the easier scanning method. Auto Scan is most useful for mobile phone users, as it requires touching only two buttons.:

1. Press **7** from the Activity Menu.
2. Press one of the following:
 - **1** to scan headers and messages.
 - **2** to scan headers only.
 - **3** to scan messages only.
3. Use the Respond and Act On options (steps 3 and 4 on page 16) as necessary. The system pauses three seconds between messages.

NOTE: Don't forget to delete messages so your mailbox doesn't fill up.

Playback Options

Use these options when listening to a message in either manual or scan mode.

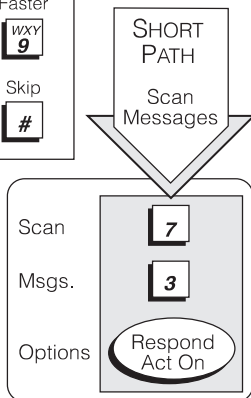
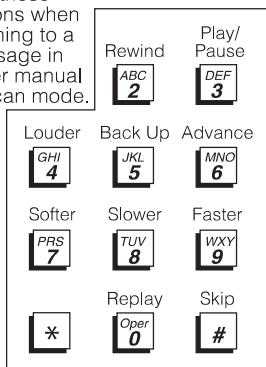

Create Personal Greetings-Basic

Your system allows you to record and store several personal greetings, each for a specific situation. You can manually activate each greeting as needed (basic mode), or you can keep a number of greetings active at once (advanced mode).

Record Greeting

NOTE: The system skips Steps 2 and 4 below if the multiple personal greetings feature isn't turned on.

1. Press **3** from the Activity Menu.
2. Listen to a summary of active greetings.
3. Press **1** to record or re-record a greeting.
4. Enter a number (**1-9**) for the greeting.
5. Speak greeting at the tone.
6. Press **1** to stop or pause.

Edit

OPTIONAL

7. Press:
 - **1** to continue.
 - **2 3** to play back.
 - *** D** to delete
 - (return to step 5).

8. Press **#** to approve.

Act on New Greeting

9. Do one of the following:
 - Press **#** to leave the greeting inactive.
 - Follow the prompts to activate the greeting.

Tips

The system greeting is always greeting 0.

The system doesn't care what single-digit number you assign to each greeting.

Keep track of your greetings by noting them on page 33 or by scanning them.

NOTE: You can also assign greetings to specific types of calls. This advanced mode allows you to have as many as three greetings active at once. See pages 20-23.

Create Personal Greetings-Basic (Cont)

Greetings

1. Press **3 3** from the Activity Menu.
2. Enter the greeting number.
3. Follow the prompts to activate for all calls or for individual call types.

Scan All Greetings

1. Press **3 2** from the Activity Menu.
2. Listen to first greeting status statement.
3. Press any combination of the following:
 - **0** to listen to a greeting.
 - **1** to re-record a greeting.
 - *** D** or *** 3** to delete and skip to the next greeting.
 - **2** to return to the previous greeting.
 - **#** to save and skip to the next greeting.

Then press *** #** to quit scanning.

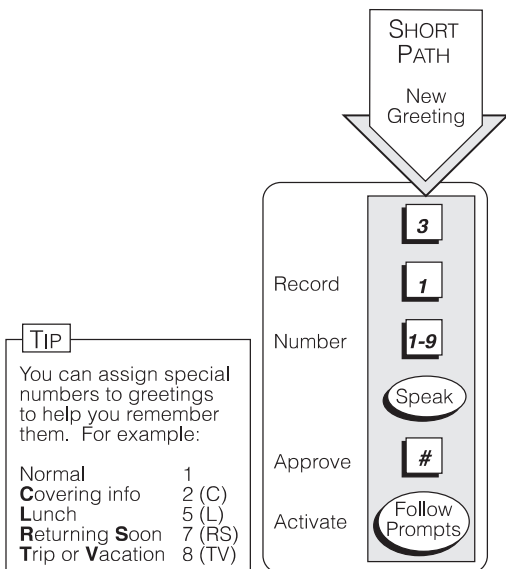

Create Personal Greetings-Advanced

After you have recorded several personal greetings, you may want to assign those greetings to specific types of incoming calls. Besides the basic mode of using one greeting for all calls, you can set up specific greetings for:

- 1) internal and 2) external calls
- 1) busy and 2) no answer calls
- 1) prime-time internal, 2) prime-time external, and 3) out-of-hours calls
- 1) prime-time busy, 2) prime-time no answer, and 3) out-of-hours calls

The first step is to define the types of calls you want to differentiate.

NOTE: Your system may not permit the use of busy/no answer call types. This is the case for systems connected to the MERLIN LEGEND system.

Define Call Types (the first time)

1. Press **3 4** from the Activity Menu.
2. Press one of the following:
 - **1** to differentiate internal/external calls.
 - **2** to differentiate busy/no answer calls (may not be available on your system).
3. Press one of the following:
 - **3** to differentiate out-of-hours calls.
 - **4** to make no distinction between prime time and out-of-hours calls.
4. Proceed to page 22 to assign greetings to call types.

Tips

When you select the out-of-hours call type, the other call types automatically apply only to prime-time calls.

You must make a choice between internal/external and busy/no answer call types. The system is not set up to handle both sets of situations simultaneously.

Create Personal Greetings-Advanced (Cont)

Call Types

Internal calls come from callers at your location. *Ex-ternal* calls come from outside your location.

Busy calls are those that come in when you are already using your phone line(s). *No answer* calls are those that come in when you do not answer. **NOTE:** These types may not be available with your system.

Out-of-hours calls are those that come in after standard business hours — defined by your system administrator. (Weekend greetings must be activated manually — basic mode only.)

Change Call Type Definition

1. Press **3 4** from the Activity Menu.
2. Press any combination of the following:
 - **1** to differentiate internal/external calls.
 - **2** to differentiate busy/no answer calls (may not be available on your system).
 - **3** to differentiate out-of-hours calls.
 - **4** to turn off out-of-hours differentiation.
 - **5** to use a single greeting for all calls (negate call type definition).
3. Press **#** to approve and proceed to page 22 to assign greetings to call types.

Tips

To *deselect* a call type, simply select another call type in its place.

To *deselect* a greeting, simply select another greeting in its place.

Create Personal Greetings-Advanced (Cont)

After you have recorded multiple personal greetings (pages 18 and 19) and defined the call types to which you want to assign those greetings (pages 20 and 21), use the following procedures to assign greetings to call types.

Assign Greetings to Call Types

1. Press **3** from the Activity Menu.
2. Listen to the summary of active greetings.
3. Press **3** to activate a greeting.
4. Enter **0-9** to indicate which greeting you want to assign to a call type.
5. Press any combination of the following:
 - **1** to use the greeting for each call type.
 - **2** to use the greeting for Internal (or Busy) calls.
 - **3** to use the greeting for External (or No Answer) calls.
 - **4** to use the greeting for Out-of-hours calls.
6. Press **#** to approve.
7. Press *** R** or *** 7** to return to the Activity Menu.

Tips

To set up different greetings strictly for prime-time and out-of hours calls, you must assign the same greeting to the two prime-time calls types (internal and external or busy and no answer).

Your specific options at step 5 depend on the call types you chose to differentiate on pages 20 and 21. Listen to the voice prompts for guidance.

Multiple Personal Greetings Flowchart

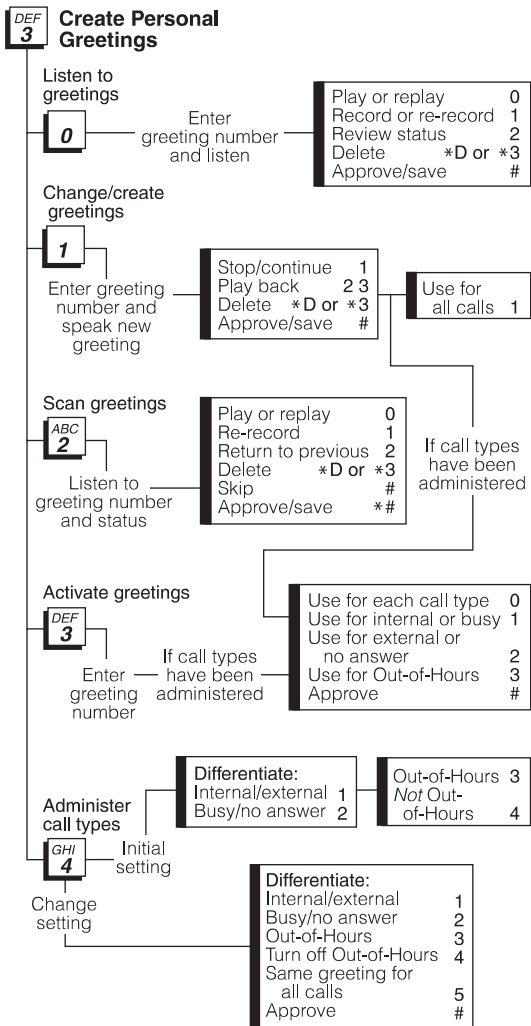

Outgoing/Filed Messages

Follow steps 1, 2, and 3 to see if an outgoing message was delivered. To modify or resend a message, follow steps 1 through 6.

Access Outgoing Messages

1. Press **4** from the Activity Menu.
2. Listen to first message header.

Select Message

3. Press any or none of the following:
 - **0** To listen to the message
 - **2 3** to play back the message header
 - *** D** or *** 3** to delete and skip to the next message
 - **2 2** to return to previous messages
 - **#** To save and skip to the next message
 - *** #** to skip to the next message category

NOTE: For *Delivered* or *Accessed* messages, you can listen to the headers only. You can't change or resend these messages. After you review an accessed message header, the system deletes the header automatically.

Modify Message

4. Press **1** to modify and/or resend the selected message.
5. Do one of the following:
 - To resend the message as is, press **#** and go to step 6.
 - To re-record:
 - a. Press **1**.
 - a. Speak message at the tone.
 - a. Edit normally.
 - a. Press **#** to approve.

Tips

You can modify/re-send three types of outgoing messages: *Undelivered* (scheduled for future delivery), *Nondeliverable* (bad address or recipient's mailbox is full), and *Filed*.

Be sure to delete messages and headers regularly. The Outgoing Message file consumes much of your system's resources.

Press **# #** to resend an undelivered message to the original recipient only (step 6).

Outgoing/Filed Messages (Cont)

Resend Message

6. Do one of the following:

- For *Filed* and *Nondeliverable* Messages -

a. Enter addresses (or list via * **L** or * **5**).

a. Press # # to approve and send immediately.

Or

Enter delivery options (see page 15) and press #.

Note: If you resend a filed message, it leaves the file cabinet portion of your mailbox. You must file a copy again to retain it (see page 15).

- For *Undelivered* Messages -

a. Enter additional addresses and press #.

Or

Enter * **1** to review and edit original addresses.

a. Change delivery times or options (see p. 15).

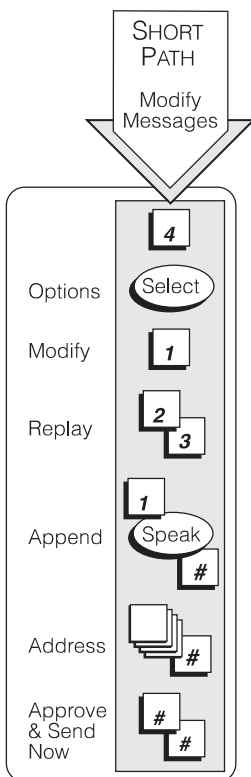

Mailing Lists

Create List

1. Press **5 1 1** from the Activity Menu.
2. Enter list ID (up to 6 letters or digits) and press **#**.
3. Press one of the following:
 - **1** to make the list private.
 - **2** to make the list public.
4. Enter an address and press **#**.
5. Repeat step 4 until list is complete.
6. Press **#** to approve.

Delete List

See *Scan List Summaries* below.

Scan List Summaries

1. Press **5 1 2** from the Activity Menu.
2. Listen to the list summary.
3. Press any combination of the following:
 - **#** to skip to next list.
 - *** D** or *** 3** to delete the *entire list*.
 - **0** to review/modify list members.
(Go to step 4 of Review/Modify List.)

Tips

When creating a list, you can also append an existing list by entering *** L** or *** 5** (at step 4). **NOTE:** after you append a list, the system asks for more extensions. **Do not** add extensions of the list just appended.

Specify an address as a number or name — press *** A** or *** 2** to switch modes. (See the alphabetic keypad reference on p. 34.)

Delete addresses in two ways: 1) Review the list until you find each address, then press *** D** or *** 3**; or 2) At step 4 on page 27, press **1** immediately, enter the address to be deleted, and press *** D** or *** 3**. Repeat for other addresses.

Mailing Lists (Cont)

Review/Modify List

1. Press **5 1 3** from the Activity Menu.
2. Enter list owner's extension and press **#**. (If you own the list, simply press **#**.)
3. Enter list ID and press **#**.
4. Listen to the first name, then press any combination of the following:
 - **#** to skip to the next name.
 - *** D** or *** 3** to delete name.
 - **2** to repeat name.
 - **2 2** to return to previous name.
 - *** 1** to review from beginning.
 - **1** to add/delete specified entries or change public/private status, then do the following:
 - a. Press **Y (9)** or **N (6)** to change status.
 - a. Enter address and press **#**.
 - a. Listen to name, and
if deleting, press *** D**
or *** 3**.
 - a. Repeat b and c for each addition/deletion.
 - a. Press *** #** to stop adding/deleting specified entries.
5. Press **#** when finished reviewing.

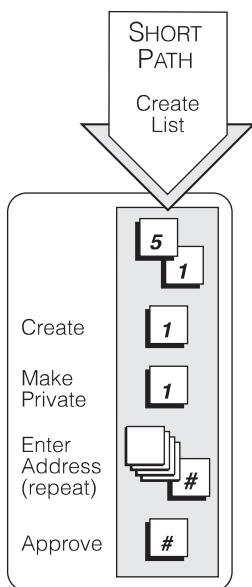

Personal Directory

The system allows you to create a personal directory of abbreviated names (*aliases*) for frequently used addresses. It's essentially a sophisticated speed dialing feature.

Create/Append Directory

1. Press **5 2 1** from the Activity Menu.
2. Enter an address and press **#**.
3. Listen to your entry's address.
If the name is incorrect, press *** D** or *** 3** to delete and repeat steps 2 and 3.
4. Enter your abbreviated version of the address (up to 10 characters) and press **#**.
5. Repeat steps 2, 3, and 4 to add more names to your personal directory.
6. When finished, press **#** to approve.

Tips

Your personal directory comes into play automatically; the system refers to your personal directory anytime you enter a name address.

The system doesn't care what numbers or letters you use for each alias.

NOTE: You must be addressing by name (*** A** or *** 2**) to use your personal directory. You can create your personal directory in name or number addressing mode.

Application

When name-addressing a voice mail message to Dr. Emilio Ramirez, you might enter **E R #** instead of the longer name. You can also use an alias when transferring out of the system (*** T** or *** 8**).

Personal Directory (Cont)

Review/Delete Directory

1. Press **5 2**.
2. Do one of the following:
 - Press **2** to review *all* aliases. While listening to each entry, press
 - **#** to skip to next alias.
 - *** D** or *** 3** to delete.
 - **2 2** to return to the previous alias.
 - *** #** to stop reviewing.
 - Press **3** to review specific aliases:
 - a. Enter alias to review and press **#**.
 - a. Listen to corresponding address.
 - a. Repeat for more aliases.
 - a. Press *** #** to stop reviewing.
3. Press *** R** or *** 7** to return to the Activity Menu.

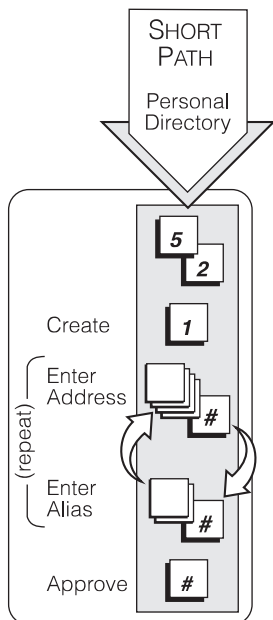

Use Directory Assistance

Directory assistance is just like a telephone book. If you know the name of a person, you can use AUDIX directory assistance to find that person's extension. Also, if you have an extension, you can use directory assistance to find the name of the person with that extension.

1. Press * * **N** or * * **6** from anywhere in the system.
2. Do one of the following:
 - If you want to hear the extension number associated with a name, enter the name (last name first, with no spaces between the first and last name), then press #.
 - If you want to hear the name associated with an address, press * **A** or * **2**, enter the address, then press #. (See the alphabetic keypad reference on p. 34)

Tips

The extension number you hear associated with a name is not always the entire address. You must add the appropriate prefix numbers for remote systems.

Leave a Call Answer Message

When leaving a call answer message, you have several options for making full and efficient use of the system. When it answers the phone, you can:

- Press **1** to skip the greeting (if you're sure you won't be missing new information the called party might have left for you in the greeting).
- Leave a detailed message (it is generally more efficient to convey information than to simply request a return call).
- Press *** D** or *** 3** to delete and start over.
- Press **1 2 3** to stop recording and review your message.

Before, or after leaving a message, you can:

- Escape to a covering extension by pressing **0**.
(It is possible that no covering extension has been assigned, and this won't work. Check with your system administrator.)
- Transfer to another extension (may not be active on your system):
 - a. Press *** T** or *** 8**.
 - a. Enter the extension.
 - a. Press **#**.
- If the receiver's mailbox is on the same system as your own, you can log into yours by pressing *** R** or *** 7** (may not be available on your system).

NOTE: if you record a message and then either hang up or go to another option, the system delivers your message to the person you are calling. You don't have to approve it. To prevent delivery of your message, you must delete it with *** 3**.

After recording a message and approving it with **#**, you can mark it as *Private* (non-forwardable) by pressing **1** or mark it as *Priority* by pressing **2**.

Personal Greetings Log

Greeting Type

Oper
0

System Greeting

1

ABC
2

DEF
3

GHI
4

JKL
5

MNO
6

PRS
7

TUV
8

WXY
9

Command Summary

BASIC COMMANDS	
Help	*H or *4
Return to Activity Menu	*R or *7
Wait	*W or *9
Look up number/name	**N or **6
Exit system	**X or **9
Transfer call to operator	*0
Delete	*D or *3
Undelete <i>(not available on all systems)</i>	**U or **8
Hold message in category	**H or **4
Transfer out	*T or *8
Relogin	**R or **7
<i>Use while addressing:</i>	
Alternate address (switch between name and number addressing)	*A or *2
Use mailing list for addressing	*L or *5

ACTIVITY MENU		
Record/Send	Get/Respond	Create Personal Greetings
1	ABC 2	DEF 3
Outgoing/Filed	Password/Mail Lists/Personal Dir.	
GHI 4	JKL 5	MNO 6
Scan		
PRS 7	TUV 8	WXY 9
Q = 7		Z = 9
*	0	#

PLAYBACK CONTROLS		
	Rewind	Pause/Play
1	ABC 2	DEF 3
Louder	Back Up	Advance
GHI 4	JKL 5	MNO 6
Softer	Slower	Faster
PRS 7	TUV 8	WXY 9
*	Listen/Replay	Skip
	0	#

Flow Chart of Shortcuts

RECORD/SEND MESSAGE



GET/RESPOND TO MESSAGES

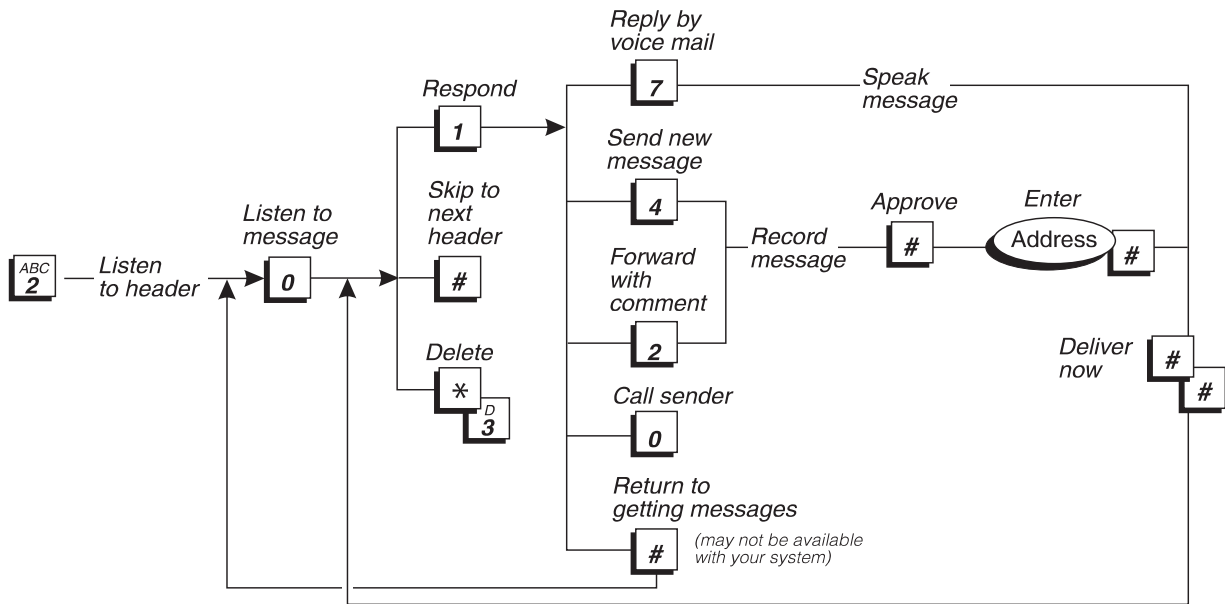

CREATE PERSONAL GREETINGS

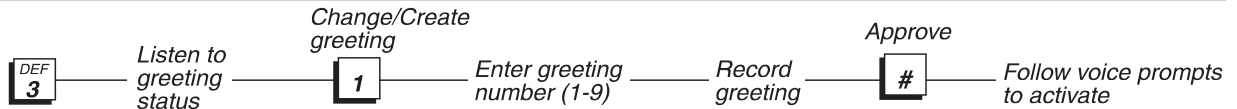

CHANGE PASSWORD



Notes

To order additional copies of this document, call the AT&T
GBCS Publications Fulfillment Center:

(800)457-1235 (U.S. phone)

(800)457-1764 (FAX)

1 (317)361-5353 (phone
outside U.S.)

For more information about AT&T documents, see the *AT&T
Global Business Communications Systems Publications
Catalog* (555-000-010)

Notice: The information in this document is subject to
change without notice. AT&T assumes no responsibility for
any errors that may appear in this document.

Prepared by Product Documentation Development, Denver,
CO.

Copyright 1994 AT&T
585-300-701, Issue 3,
November, 1994

